



OWNER'S MANUAL

LG ThinQ[®] Speaker

Please read this manual carefully before operating your set and retain it for future reference.

MODEL
WK7



MFL70521719

www.lg.com

Copyright © 2018 LG Electronics Inc. All Rights Reserved

Safety Information



CAUTION: TO REDUCE THE RISK OF ELECTRIC SHOCK DO NOT REMOVE COVER (OR BACK) NO USER-SERVICEABLE PARTS INSIDE REFER SERVICING TO QUALIFIED SERVICE PERSONNEL



This lightning flash with arrowhead symbol within an equilateral triangle is intended to alert the user to the presence of uninsulated dangerous voltage within the product's enclosure that may be of sufficient magnitude to constitute a risk of electric shock to persons.



The exclamation point within an equilateral triangle is intended to alert the user to the presence of important operating and maintenance (servicing) instructions in the literature accompanying the product.

WARNING: TO PREVENT FIRE OR ELECTRIC SHOCK HAZARD, DO NOT EXPOSE THIS PRODUCT TO RAIN OR MOISTURE.

CAUTION: The apparatus should not be exposed to water (dripping or splashing) and no objects filled with liquids, such as vases, should be placed on the apparatus.

WARNING: Do not install this equipment in a confined space such as a book case or similar unit.

CAUTION: Do not use high voltage products around this product. (ex. Electrical swatter) This product may malfunction due to electrical shock.

CAUTION: No naked flame sources, such as lighted candles, should be placed on the apparatus.

CAUTION: Do not block any ventilation openings. Install in accordance with the manufacturer's instructions.

Slots and openings in the cabinet are provided for ventilation and to ensure reliable operation of the product and to protect it from over heating. The openings shall never be blocked by placing the product on a bed, sofa, rug or other similar surface. This product should not be placed in a built-in installation such as a bookcase or rack unless proper ventilation is provided or the manufacturer's instruction has been adhered to.

CAUTION concerning the Power Cord

The Power Plug is the disconnecting device. In case of an emergency, the Power Plug must remain readily accessible.

Check the specification page of this owner's manual to be certain of the current requirements.

Do not overload wall outlets. Overloaded wall outlets, loose or damaged wall outlets, extension cords, frayed power cords, or damaged or cracked wire insulation are dangerous. Any of these conditions could result in electric shock or fire. Periodically examine the cord of your device, and if its appearance indicates damage or deterioration, unplug it, discontinue use of the device, and have the cord replaced with an exact replacement part by an authorized service center. Protect the power cord from physical or mechanical abuse, such as being twisted, kinked, pinched, closed in a door, or walked upon. Pay particular attention to plugs, wall outlets, and the point where the cord exits the device.

NOTICE: For safety marking information including product identification and supply ratings, please refer to the main label on the bottom or the other surface of the product.

CAUTION when using this product in environments of low humidity

- It may cause static electricity in environments of low humidity.
- It is recommended to use this product after touching any metal object which conducts electricity.

For models using an adapter

Only use the AC adapter supplied with this device. Do not use a power supply from another device or another manufacturer. Using any other power cable or power supply may cause damage to the device and void your warranty.

Symbols

~	Refers to alternating current (AC).
≡	Refers to direct current (DC).
⊞	Refers to class II equipment.
⏻	Refers to stand-by.
I	Refers to "ON" (power).
⚡	Refers to dangerous voltage.

Table of Contents

1 Getting Started

- 2 Safety Information
- 6 Unique features
- 6 Introduction
- 7 Front
- 8 Rear

2 Connecting

- 9 Network connection
- 9 Setting up the Speaker
 - Connecting the AC Adapter
 - Installing "Google Home" App
 - Launch the app to connect Wi-Fi
- 13 – Reference site for Google Assistant Help

3 Operating

- 14 Basic Operations
 - Function LED status
 - Simple Operation Guide
- 16 How to use the Google Assistant
 - Google Assistant LED status
 - Talk to the Google Assistant
 - Control Smart Home devices
 - Voice command
- 19 LG Wi-Fi Speaker
 - Installing "LG Wi-Fi Speaker" App
 - BLUETOOTH connection lock
 - Sound adjustment
- 21 Using BLUETOOTH® technology
 - Listening to music stored on the BLUETOOTH devices
- 23 Other Operations
 - Turn off the microphone temporarily
 - Auto function change
 - Edit speaker name
 - Resetting

4 Troubleshooting

- 25 Troubleshooting
 - General
 - Network
 - Application

5 Appendix

- 27 Trademarks and Licenses
- 27 Handling the Unit
- 28 OPEN SOURCE
- 29 Specifications

1

2

3

4

5

Unique features

BLUETOOTH®

Listen to music stored on your **Bluetooth** device.

"Google Home" application

You can enjoy various functions of this speaker by connecting to network and your smart device with "Google Home" app.

The speaker and your smart device must be connected to the same network. Visit or "Google Play" or "App Store" to search for "Google Home" app. For detailed information, refer to page 10

Voice recognition

You can use a variety of voice commands to control the speaker with Google Assistant.

"LG Wi-Fi Speaker" application

Listens to music stored on your smart device.

You can control this speaker with your iPhone or Android device via "LG Wi-Fi Speaker" app. Visit "Google Play" or "App Store" to search for "LG Wi-Fi Speaker" app. For detailed information, refer to page 19

- Depending on the application's version and the software of smart device, "LG Wi-Fi Speaker" app may not be operated normally.
- Some smart devices may not be compatible with this speaker.

Introduction

Symbol used in this manual

Note

Indicates special notes and operating features.

Caution

Indicates cautions for preventing possible damages from abuse.

Front

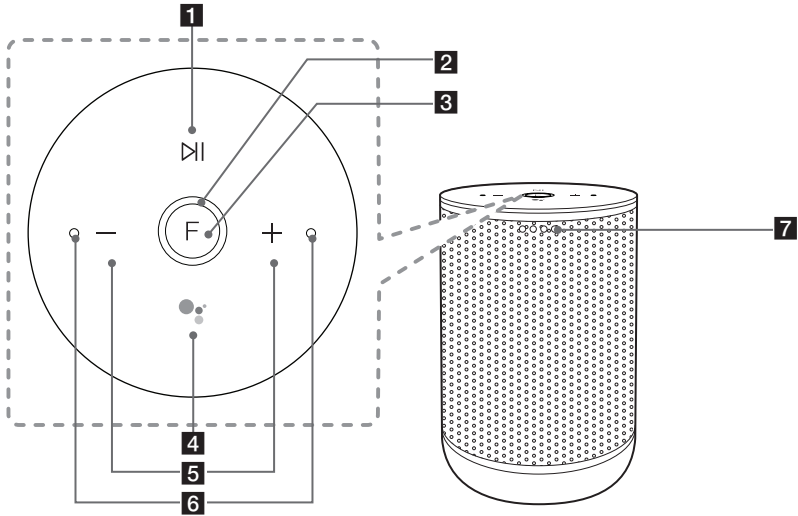

1 ▷||

Plays, pauses or skip playback.

2 Function LED

Changes LED status in according function.

Bluetooth: Blue / **Wi-Fi:** White (Page 14)

3 F (Function)

Changes Wi-Fi or **Bluetooth**. (Page 15)

4 ●●

- Use instead of saying "Hey Google" by long pressing the ●● (Page 16)
- Plays or pauses a music and stops the Google Assistant feedback. (Page 15)

5 —, +

Adjusts the volume.

6 Built-in microphones

7 Google Assistant LED

Changes LED status according to Google Assistant performance. (Page 16)

! Note

Precautions in using the touch buttons

- Use the touch buttons with clean and dry hands.
 - In a humid environment, wipe out any moisture on the touch buttons before using.
- Do not press the touch buttons hard to make it work.
 - If you apply too much strength, it can be damaged the sensor of the touch buttons.
- Touch the button that you want to work in order to operate the function correctly.
- Be careful not to have any conductive material such as metallic object on the touch buttons. It can cause malfunctions.

Rear

1

Getting Started

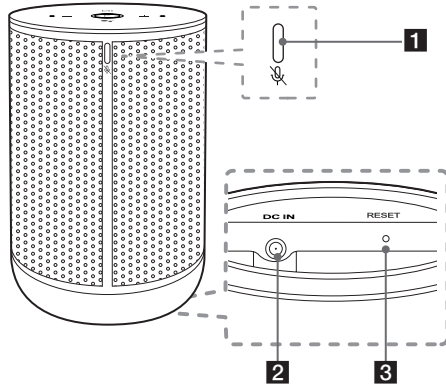

1  (Microphone off) button
Enables or disables the Google Assistant
Microphone (voice recognition) (Page 23)

2 **DC IN** (AC adapter input)
3 **RESET**
Initialize information of existing connection.
(Page 24)

Network connection

You can enjoy various functions of this speaker by connecting to network and your smart device with "Google Home" app.

Choose the connection method considering your network environment.

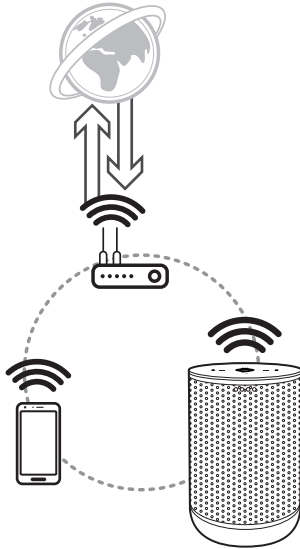

The "Google Home" app is required to connect the speaker wirelessly to the network.

Setting up the Speaker

Connecting the AC Adapter

Connect the speaker to the power supply with the supplied AC adapter.

1. Connect the supplied AC power cord to DC IN adapter input.
2. Plug the AC power cord into an AC outlet.

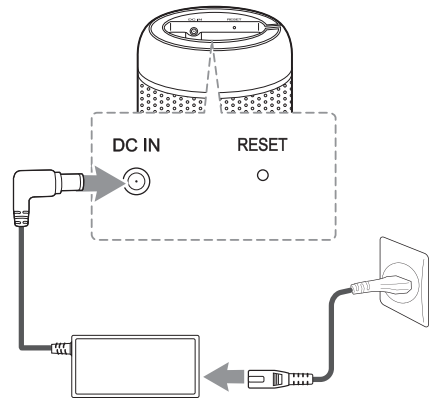

3. Function LED rotates for tens of seconds (Approx. 30 ~ 50 seconds) during booting.
4. The speaker has completed booting when Function LED blinks in white with the sound.

! Note

If the speaker is connected to Wi-Fi, Function LED is solid white when booting is completed.

! Caution

Only use the AC adapter supplied with this device. Do not use a power supply from another device or manufacturer. Using any other power cable or power supply may cause damage to the device and void your warranty.

Installing “Google Home” App

The “Google Home” app allows you to use various functions of this speaker through your smart device. There are a ways to install “Google Home” app onto your Smart device.

Requirements before setup

- A wireless router must be connected to the internet. A smart device such as Android or iOS devices must be connected to the wireless router via Wi-Fi connection.
- It needs Google account to use this app. During connect Wi-Fi, this app may request to create Google account.

Through “Google Play or “App Store”

1. Tap the “Google Play Store” icon or “App Store” icon on your smart device.
2. Type in “Google Home” in the search bar and tap “Search” on “Google Play” or “App Store”
3. Select “Google Home” in the search result list to download.

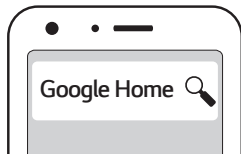

! Note

- Depending on the device version, “Google Home” app may not work.
- For more information, visit the web site. <https://www.google.com/cast/setup/>

Launch the app to connect Wi-Fi

Make sure your smart device Wi-Fi feature is turned on. Once a connecting operation is performed, it does not need to be performed again.

! Note

In case of iOS devices, it should be turned on **Bluetooth** setting on your smart device.

1. Tap the “Google Home” icon to launch the app.



2. Follow the screen on app to set speaker. Follow these instructions in order.

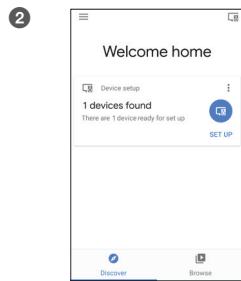
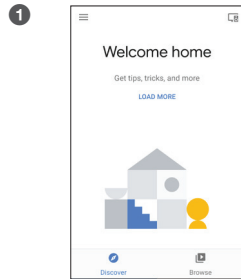

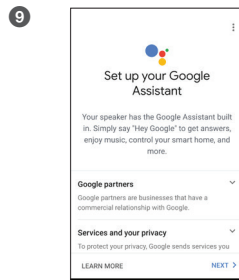
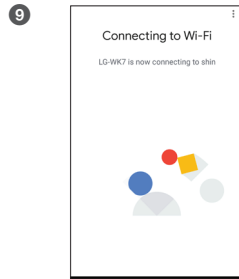
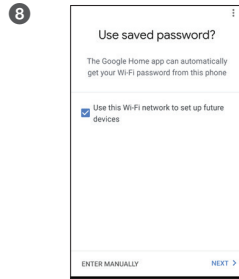
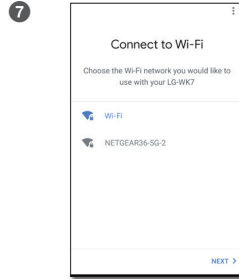
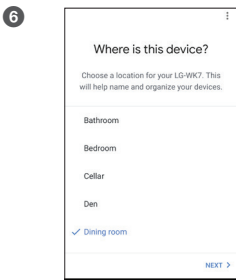
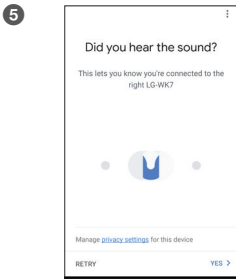
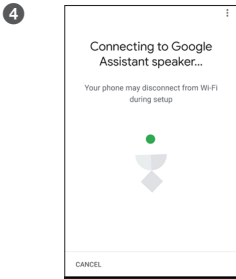
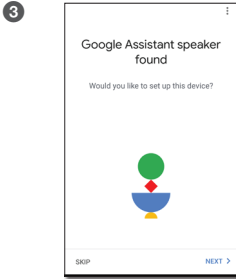

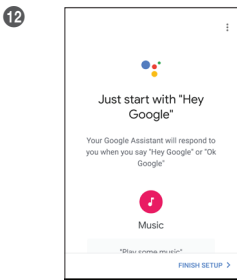
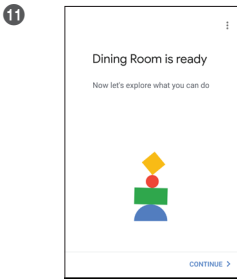
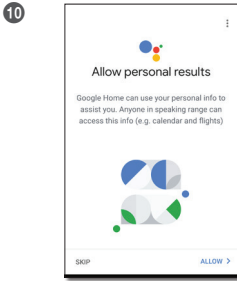

3. When the speaker is properly connected to Wi-Fi, the Function LED will be solid white with sound.

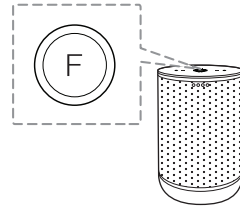

! Note

- If the app is already installed, this speaker is display in main screen of the app.
- Depending on wireless router status, it might not work well Wi-Fi connection.
- It is recommended that you use WiFi Group Play with less than 5 speakers.
- For more information (Set up, Usage, Help etc.), research "Google Assistant Help" or visit the web site. <http://support.google.com/assistant>
- The speaker is not available for use on some functions from the "Google Assistant Help" site. (ex. Call etc.) (Page 13)
- "Google Home" app is provided by Google. It might be revised by a change of Google Policy.
- The speaker is not compatible with "Smart ThinQ" app. Therefore it is not available in setup and cannot be controlled by using "Smart ThinQ" app

! Note

- For more information on the setup, visit the web site. <https://support.google.com/assistant/answer/7538816>
- Use the same Wi-Fi connection to set the speaker and your smart device.
- If the **Bluetooth** setting turned on your smart device, it will be easy to connect Wi-Fi.
- During installation, you should create a speaker name. It is needed when pairing the **Bluetooth** device. You can check and edit the speaker name. Follow the "Edit speaker name". (Page 24)

Reference site for Google Assistant Help

Set up the Google Assistant on your speakers	https://support.google.com/assistant/answer/7538816
Listen to music	https://support.google.com/assistant/answer/7539710
Play music on your TV or speakers	https://support.google.com/assistant/answer/7539867
Play TV shows & movies	https://support.google.com/assistant/answer/7539991
Control smart home devices	https://support.google.com/assistant/answer/7540703
Create a shopping list	https://support.google.com/assistant/answer/7540969
Buy items on your shopping list	https://support.google.com/assistant/answer/7384588#speaker
Set up and manage My Day	https://support.google.com/assistant/answer/7393908#speaker
Listen to radio	https://support.google.com/assistant/answer/7540307
See which Google Account is linked to your Assistant	https://support.google.com/assistant/answer/7539992
Control volume of your speakers	https://support.google.com/assistant/answer/7538817
Change your language	https://support.google.com/assistant/answer/7394513#speaker

Basic Operations

Function LED status

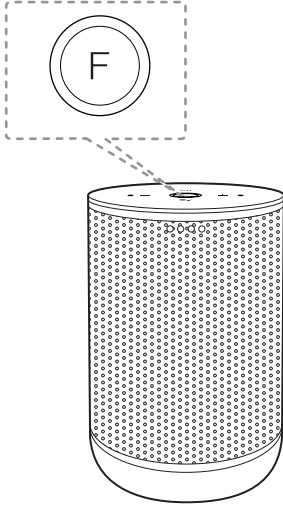







LED	Status	Description
	LED blinks in white.	Ready for Wi-Fi connection.
	LED turns on white with the sound.	Wi-Fi connection is success.
	LED blinks in Blue with the sound.	Searching for Bluetooth device.
	LED turns on Blue with the sound.	Bluetooth device is connected.

! Note

When operation of speaker is completed, Function LED turns off after 3 seconds.

Simple Operation Guide

Function	How to	Status
Bluetooth pairing	When Function LED blinks in blue, select speaker name that is set on "Google Home" app from phone's smart device list	Function LED turns on blue with the sound.
Play / Pause	Tap  or 	Plays or pause a song.
Forward skip	Tap  X 2	Plays next song.
Backward skip	Tap  X 3	Plays previous song.
Wi-Fi / Bluetooth	Tap F	Changes function and Function LED's color. (Bluetooth : Blue / Wi-Fi: White)
Volume control	Tap + or - (0-15 level).	When you adjust volume, the Google Assistant LED changes.
The Google Assistant	Long press  2 seconds.	Activates the Google Assistant. (= Hey Google)
	Tap 	Stops Google Assistant feedback
Enable/ Disable Voice recognition	Press  (Microphone off) on rear of speaker.	<ul style="list-style-type: none"> - When microphone is off, the Google Assistant LED turns on amber with "The MIC is muted" sound. - When microphone is on, the Google Assistant LED turns off with "The MIC is back on" sound.
Reset	Press RESET for 5 seconds. (Page 24)	When speaker enter reset mode, Function LED starts to rotate quickly with sound.

Note

- Play, pause, skip, volume may not be supported depending on the your smart device or some of TV operated differently.
- The speaker might not synchronize volume with some of TV.
- Some of PC may not be automatically connected to **Bluetooth**.

How to use the Google Assistant

Google Assistant LED status

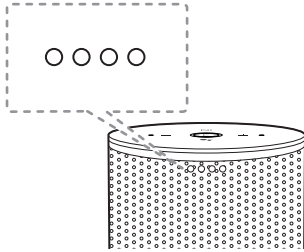

LED	Status	Description
○ ○ ○ ○	All four LEDs are on.	Ready to listen to your voice command.
◌◌◌◌◌◌◌◌◌	All four LEDs blink.	Responds to your voice command.
○ ○ ○ ○	Microphone is off and the solid amber LED will be on.	Voice recognition is disable

! Note

The Google Assistant LED status may be changed without notice.

Talk to the Google Assistant

You can use a variety of voice commands to control this speaker with the Google Assistant. Try to say a voice command to the speaker. The speaker will activate the Google assistant and perform your voice command.

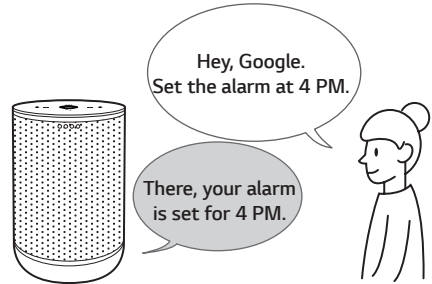

1. Turn on the speaker and connect Wi-Fi. Follow the "Setting up the Speaker". (page 9-13)
2. Say "Hey Google".
Or long press  for 2 seconds on top of the speaker.
Then the speaker is activated and ready to receive your voice commands.

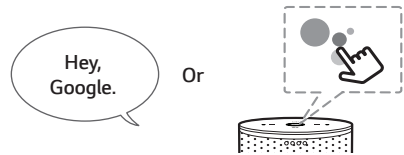

3. Just say the thing you want to do. Then the speaker recognizes and performs your voice command.
4. After a few seconds, the Google Assistant will respond to your command.

! Note

Each time you use voice recognition, say "Hey, Google" or tap and long press the .

Comfortable Function

With the Google Assistant built in, you can control compatible smart home devices such as TV's, lights, switches, plugs, thermostats and more by simply using your voice.

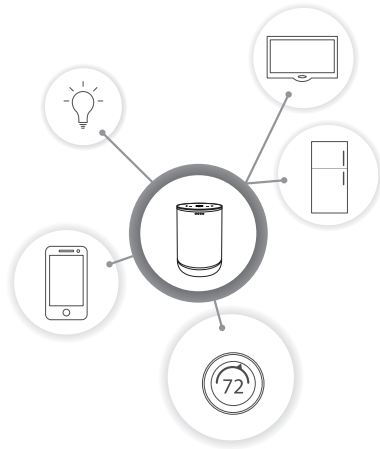

For more information, visit the below web site.

- **Set up, Usage and more:** <http://support.google.com/assistant/answer/7540703>
- **Compatible LG appliance models:** Visit <http://www.lg.com> and then search the information



Voice command

1. Time
"What time is it?", "What time is it now?", "What time is it in Spain?"
2. Weather
"What's the weather?", "What's the weather this weekend?", "What's the weather in Paris?", "Will it rain tomorrow?"
3. Plan
"Tell me about my day", "What's my next meeting?", "Set a reminder to check schedule at 6pm."
4. Alarms
"Set an alarm", "Set an alarm for 9am", "Wake me up at 9am", "What alarms are set?"
5. Music
"Play the music.", "Next song.", "Previous song.", "Pause the music"
6. Volume
"Volume level 9.", "Maximum volume.", "Mute.", "Turn it up", "Turn it down"
7. Smart Home devices
"Set the heat to 70"
"Turn on lights in the kitchen"
"Watch on TV"

! Note

For more information on the voice commands, refer to the "Google Home" app screen or visit the web site. <http://support.google.com/assistant>

Note

- After connecting to Wi-Fi, this function is available to use. If Function LED (White) blinks, the speaker is not connected to Wi-Fi. Follow the "Installing "Google Home" App" and try again. (page 10-13)
- If the Google Assistant LED is solid amber, the microphone is off. In that case, the Google Assistant is not available to receive your comment. Press the  button on back of the speaker.
- If the Google Assistant fails to understand your commands, it will say answers such as "Sorry, I can't help with that yet", "My apologies. I don't understand."
- Avoid noisy places, because the speaker may not receive your commands or "Hey, Google". Instead of "Hey Google", long press  for 2 seconds.
- When the voice recognition time limit is exceeded on smart devices, this function automatically cancels.
- Speaking with correct pronunciation will increase the voice recognition rate.
- The Google Assistant may be slow to recognize or act depending on the Wi-Fi connection status or Google server status..

LG Wi-Fi Speaker

The "LG Wi-Fi Speaker" app is provided by LG Electronics. This app allows you to use various functions of this speaker through your smart device:

Requirements before using

You should connect to Wi-Fi by using "Google Home" app prior to use this app. (Page 10-13)

Note

"LG Wi-Fi Speaker" app will be available in the following software versions: Android OS: Ver 5.0 (or later) iOS: Ver 10 (or later)

Enjoying music on your device and home network server

You can listen to music on your smart device and home network server.

Using Chromecast built-in

You can enjoy music contents through this speaker.

Installing "LG Wi-Fi Speaker" App

Through Apple "Google Play" or "App Store"

1. Tap the "Google Play Store" icon or "App Store" icon on your smart device.
2. Type in "LG Wi-Fi Speaker" in the search bar and tap "Search".
3. Select "LG Wi-Fi Speaker" in the search result list to download.

Note

Depending on the device, "LG Wi-Fi Speaker" app may not work.

Setting and controlling the speaker



You can manage the speaker settings and control the speaker.

Note



For more information of "LG Wi-Fi Speaker", follow the application instructions or see the owner's manual of "LG Wi-Fi Speaker".

BLUETOOTH connection lock

You can limit **Bluetooth** connection to only **Bluetooth** function to prevent unintended **Bluetooth** connection.









1. Install the "LG Wi-Fi speaker" app.
Follow the "LG Wi-Fi Speaker" (page 19)
2. Follow these instructions in order:
[] → [My Speakers] → [] → [Bluetooth connection restriction]
3. Tap  on [Bluetooth connection restriction]

! Note

- When you turn off this function, tap  on [Bluetooth connection restriction] again.
- [] → [My Speakers] → [] → [Bluetooth connection restriction]
- If a **Bluetooth** device has paired to the speaker previously, you can connect the **Bluetooth** device and the speaker.

Sound effect

This system has a number of pre-set surround sound fields. You can select a desired sound effect by using "LG Wi-Fi Speaker" app.

Status	Description
Function	
Enhanced Bass  Clear Vocal  Enhanced Bass + Clear Vocal	You can enjoy Clear Vocal and Enhanced Bass at the same time.
Enhanced Bass  Clear Vocal  Enhanced Bass	You can enjoy Wide sound field and rich bass with emphasis the bass and warmth of the music. - Enhanced Bass is more effective for music with bass.
Enhanced Bass  Clear Vocal  Clear Vocal	You can enjoy High-fidelity sound with improved the vocal clarity of every lyric. - Clear Vocal is more effective for music with vocal.
Enhanced Bass  Clear Vocal  Standard	You can enjoy pure and natural sound.

! Note

- When you turn the speaker back on, the last used option will be on.
- When you select "Standard" "Enhanced Bass", "Clear Vocal" or "Clear Vocal + Enhanced Bass" sound effect, you can enjoy premium sound with MERIDIAN technology.
- Because fine-tune sound to provide optimal high-quality sound, it might be a little difference between sound effect modes.

Using BLUETOOTH® technology

About BLUETOOTH

Bluetooth is wireless communication technology for short range connection.

The sound may be interrupted if the connection has interference by some other electronic waves or you connect the **Bluetooth** in some other room.

Connecting individual devices under **Bluetooth** wireless technology does not incur any charges. A mobile phone with **Bluetooth** wireless technology can be operated via the Cascade if the connection was made via **Bluetooth** wireless technology.

- Available Devices: Smart phone, Notebook, etc.
- Version: 4.2
- Codec: SBC

BLUETOOTH Profiles

In order to use **Bluetooth** wireless technology, devices must be able to interpret certain profiles. This unit is compatible with following profile.

A2DP (Advanced Audio Distribution Profile)

Listening to music stored on the BLUETOOTH devices

Pairing your unit and BLUETOOTH device

Before you start the pairing procedure, make sure the **Bluetooth** feature is turned on in to your **Bluetooth** device. Refer to your **Bluetooth** device's user guide. Once a pairing operation is performed, it does not need to be performed again.

1. Turn on the speaker and connect Wi-Fi. Follow the "Setting up the Speaker". (page9-13)

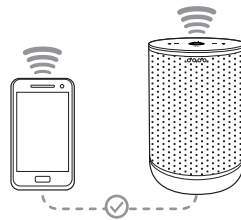

2. When you change to **Bluetooth** function by pressing the **F** button, the Function LED's color will change from white to blue.
 - Function LED (Blue) will blink.

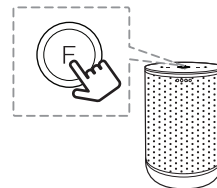

3. Operate the **Bluetooth** device and perform the pairing operation. When searching for this unit with the **Bluetooth** device, a list of the devices found may appear in the **Bluetooth** device display depending on the type of **Bluetooth** device. Your unit appears as "Speaker name (App setup)".

4. Select "Speaker name (App setup)".

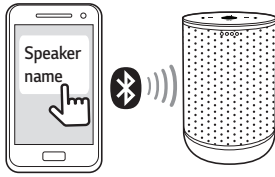

Note

- App setup means that you set the name in the "Google Home" app. For example, if the speaker name is set to Smart speaker in the "Google Home" app, you will see "Smart speaker" on your **Bluetooth** device.
- You may check and edit the speaker name on "Google Home" app (Page 24)
- Depending on the **Bluetooth** device type, some device have a different pairing way. Enter the PIN code (0000) as needed.

5. When this unit is successfully connected with your **Bluetooth** device, the Function LED will be solid blue with sound.

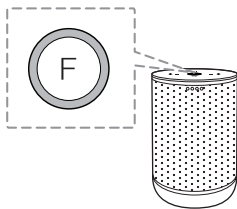

6. Listen to music.
To play a music stored on your **Bluetooth** device, refer to your **Bluetooth** device's user guide.

Note

- When using **Bluetooth** technology, you should be as close as possible when you are attempting to make a connection between the unit and a **Bluetooth** device. You should also keep the distance close. However you may experience issues in the cases below:
 - There is an obstacle between the unit and the **Bluetooth** device.
 - There is a device using same frequency with **Bluetooth** technology such as a medical equipment, a microwave or a wireless LAN device.
- If **Bluetooth** connection does not work well, go to step 1 of "Pairing your unit and BLUETOOTH device" and try again.
- The sound may be interrupted when the connection has interference from some other electronic waves.
- Pairing is limited to one per unit and multi-pairing is not supported
- Depending on the type of the device, you may not be able to use the **Bluetooth** function.
- You can enjoy **Bluetooth** function using Smart phone, Notebook, etc..
- The more distance between the unit and the **Bluetooth** device, the lower the sound quality becomes.
- **Bluetooth** connection will be disconnected when the unit is turned off or the **Bluetooth** device gets too far from the unit.
- When **Bluetooth** connection is disconnected, connect the **Bluetooth** device to the unit again.
- When you connect **Bluetooth** device (iOS device etc.) to this unit or operate the device, the volume level can be synchronized with each other.
- When the unit is not connected, Function LED (Blue) will blink.

! Note

- **Bluetooth** connection will be disconnected when you change the **Bluetooth** function to another function. When you switch to **Bluetooth** function again, the speaker will automatically reconnect the **Bluetooth** device. Some **Bluetooth** devices may not be connected in automatic.
- Some of PC may not be automatically connected to **Bluetooth**.

Using Voice command to connect Bluetooth

If the speaker has paired to a **Bluetooth** device before, you can use "Google Assistant" to pair **Bluetooth**. Say "Connect", "Connect to Bluetooth" or "Hey Bluetooth".

To disconnect it, say "Cancel", "Unpair devices" or "Clear all devices".

Controls connected Bluetooth device

You can control connected **Bluetooth** device from the unit; play, pause, skip, volume.

! Note

- Only Android OS and iOS is available to use this function.
- This function may not be supported depending on the **Bluetooth** device or some of TV operated differently.
- You can control connected **Bluetooth** devices by voice recognition. Follow the "How to use Google Assistant" (Page 16-18).

Other Operations**Turn off the microphone temporarily**

You can turn off the microphone to temporarily disable the detect voice recognition by pressing  (Microphone off) button. All the Google Assistant LED turns amber and "The mic is muted" is heard.

To cancel it, press  (Microphone off) again. the Google Assistant LED turns off and "The mic is back on" is heard.

Auto function change

This speaker recognizes input signals Wi-Fi, **Bluetooth** and then changes suitable function automatically.

When Wi-Fi signal comes in

When you use the Google Cast and voice command this unit changes the function to Wi-Fi.

When you try to connect Bluetooth device

When you try to connect your **Bluetooth** device to this unit, **Bluetooth** function is selected. Play your music on the **Bluetooth** device.

! Note

If the **Bluetooth** connection lock function is set, **Bluetooth** connection will be only available on **Bluetooth** function. (Page 20)

Edit speaker name

You can check and edit the speaker name on the "Google Home" app, follow these instructions.

[Home] → [Settings] → [Device info] → [Name]

Resetting

To initialize information of existing connection, follow these instructions.

1. Press and hold the **RESET** button for 5 seconds. The Function LED will be filled when **RESET** is pressed.
2. When the speaker enters reset mode, Function LED starts to rotate quickly with sound. Wait until resetting is complete.



Note

It takes about 1 minute to reset the speaker.

3. The speaker has completed resetting when Function LED blinks slowly with sound.

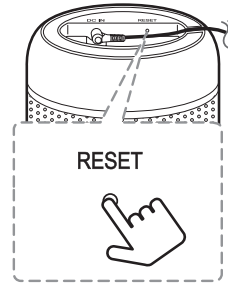



Note

- The first beep sound means that the speaker entered reset mode. Please don't unplug the power cord.
- If you do not press and hold the **RESET** button for more than 5 seconds, speaker is not reset.
- When you reset this speaker, it needs to reconnect to Wi-Fi or **Bluetooth**.

Troubleshooting

General

Problem	Cause & Correction
No Power	<ul style="list-style-type: none"> The power cord is unplugged. Plug in the power cord. Check whether electricity failed. Check the condition by operating other electronic devices.
No sound or sound distortion.	<ul style="list-style-type: none"> The unit or your smart device's volume is set to minimum. Check and adjust the volume of the speaker or your device's volume. When you use an external device at high volume, the sound quality may be deteriorated. Lower the volume of the devices. If you use the unit for purposes other than listening to music, the sound quality may be lowered or the unit may not work properly.
Wi-Fi connection does not work well.	<ul style="list-style-type: none"> Check your router. Try turning it off and back on. Check that the Wi-Fi feature is turned on in your smart device. Check that the speaker and your smart device are connected to same Wi-Fi.
Bluetooth pairing does not work well.	<ul style="list-style-type: none"> Switch Bluetooth off and on again on your Bluetooth device, then try pairing again. Be sure your Bluetooth device is on. Remove the obstacle in the path of the Bluetooth device and the unit. Depending on the type of the Bluetooth device or surrounding environment, your device may not be paired with the unit.
Voice recognition does not work well.	<ul style="list-style-type: none"> The speaker may not be recognized because of the surrounding noise. Instead of "Hey Google", long press  for 2 seconds. Check and make sure the microphone is not turned "off". Press the  button.
The unit does not operate normally.	<ul style="list-style-type: none"> In case of malfunction, please use the unit in proper place where the temperature or humidity is not so high or low. When Function LED is blinking in red, unplug the power cord from the electrical outlet and plug it again. When Function LED is solid red, press the RESET button for 5 seconds. (Page 24)
The unit does not connect with Bluetooth device.	<ul style="list-style-type: none"> Turn off the Bluetooth connection lock function. (Page 20)
Above solutions do not work.	<ul style="list-style-type: none"> Press the RESET button for 5 seconds. (Page 24)

Network

Symptoms	Cause & Solution
Cannot connect the speaker to your home network.	The wireless communication may be interrupted from household devices that are using radio frequencies. Move the speaker away from them.
Media servers are not displayed on the device list.	<ul style="list-style-type: none"> The firewall or anti-virus software on your media server is running. Turn off the firewall or anti-virus software running on your media server. Make sure that the speaker is connected to the same network that your media server is connected.
The application doesn't work properly.	<p>Is the application plugged in?</p> <ul style="list-style-type: none"> Plug in the application. <p>Is the LAN cable connected to the wireless router and the application properly?</p> <ul style="list-style-type: none"> Connect the LAN cable to the LAN port on the back of the application and to your wireless router. <p>If you restart the router?</p> <ul style="list-style-type: none"> You need to turn the speaker's power off and on again. <p>If you install new router.</p> <ul style="list-style-type: none"> You need to perform a factory set and setup the network connection for speaker.

Application

Symptoms	Cause & Solution
The application doesn't work properly.	<p>Does an error occur when accessing the app?</p> <ul style="list-style-type: none"> Make sure that your smart device is compatible with the app. Make sure that the application is the latest version. Make sure that the speaker's front LED turns from red to white.

Trademarks and Licenses



The **Bluetooth**® word mark and logos are registered trademarks owned by the Bluetooth SIG, Inc. and any use of such marks by LG Electronics is under license.

Other trademarks and trade names are those of their respective owners.

Handling the Unit

When shipping the unit

Please save the original shipping carton and packing materials. If you need to ship the unit, for maximum protection, re-pack the unit as it was originally packed at the factory.

Keeping the exterior surfaces clean

- Do not use volatile liquids such as insecticide spray near the unit.
- Wiping with strong pressure may damage the surface.
- Do not leave rubber or plastic products in contact with the unit for a long period of time.



Cleaning the unit

To clean the player, use a soft, dry cloth. If the surfaces are extremely dirty, use a soft cloth lightly moistened with a mild detergent solution. Do not use strong solvents such as alcohol, benzene, or thinner, as these might damage the surface of the unit.



OPEN SOURCE

You can find "Open Source Software Notice" at the "LG Wi-Fi Speaker" app or "Google Home" app





LGE OPEN SOURCE

1. Launch "LG Wi-Fi Speaker" app on your smart device.
2. Follow these instructions in order:
 →  Settings]
3. Tap [Open source licenses] on  Settings]
Shows LGE Open Source Software Notice.

Chromecast and the Google Assistant OPEN SOURCE

1. Launch "LG Wi-Fi Speaker" app on your smart device.
2. Follow these instructions in order:
 →  Settings] → [Chromecast] → [Chromecast built-in open legal documents]
3. Tap [Open source licenses] on [Chromecast built-in open legal documents] Shows Chromecast and Google Assistant Open Source Software Notice.

Android Things OPEN SOURCE

1. Launch "Google Home" app on your smart device.
2. Follow these instructions in order:
 →  → [Settings] → 
3. Tap [Open source licenses] on  of Device settings] Shows Android Things Open Source Software Notice.

OPEN SOURCE SOFTWARE NOTICE INFORMATION

To obtain the source code under GPL, LGPL, MPL, and other open source licenses, that is contained in this product, please visit

<http://opensource.lge.com>.

In addition to the source code, all referred license terms, warranty disclaimers and copyright notices are available for download. LG Electronics will also provide open source code to you on CDROM for a charge covering the cost of performing such distribution (such as the cost of media, shipping and handling) upon email request to opensource@lge.com. This offer is valid for a period of three years after our last shipment of this product. This offer is valid to anyone in receipt of this information.

For more information about Google's open source, visit device settings of Google Home app.

Specifications

Speaker	
Power consumption	Refer to main label. Networked standby : 4.7 W
AC adapter	<ul style="list-style-type: none">• Model: ADS-45SN-19-2 19040G• Manufacturer: SHENZHEN HONOR ELECTRONIC CO,LTD• Input: 100-240 V~ 50-60 Hz• Output: 19 V  2.1 A
Dimensions (W x H x D)	Approx. 135 mm X 210.7 mm X 135 mm
Operating temperature	5 °C to 35 °C
Operating humidity	5 % to 60 %

- Design and specifications are subject to change without notice.





OWNER'S MANUAL

LG

Wi-Fi Speaker

Table of Contents

1 Getting Started

- 3 "LG Wi-Fi Speaker"
- 3 – Installing "LG Wi-Fi Speaker" App

2 Operating

- 4 Enjoying the Music with "LG Wi-Fi Speaker" app
 - 4 – Overview of the side menu
 - 5 – Overview of [My Speakers]
 - 5 – Playing a song
 - 6 – Managing a song
 - 7 – Overview of Playback
- 9 Settings
 - 9 – Settings of the connected speaker
 - 11 – Settings of "LG Wi-Fi Speaker" app

"LG Wi-Fi Speaker"

The "LG Wi-Fi Speaker" app is provided by LG Electronics. This app allows you to use various functions of this speaker through your smart device:

Requirements before using

You should connect Wi-Fi by using "Google Home" app prior to use this app.

! Note

"LG Wi-Fi Speaker" app will be available in version of the software as follow; Android OS : Ver 5.0 (or later) iOS : Ver 10 (or later)

Enjoying music on your device and home network server

You can listen to the music on your smart device and home network server.

Using Chromecast built-in

You can enjoy music contents through this speaker.

Installing "LG Wi-Fi Speaker" App

Through Apple "App Store" or Google "Play Store"

1. Tap the Apple "App Store" icon or Google "Play Store" icon.
2. Type in "LG Wi-Fi Speaker" in the search bar and tap "Search".
3. Select "LG Wi-Fi Speaker" in the search result list to download.

! Note

Depending on the device, "LG Wi-Fi Speaker" app may not work.

Setting and controlling the speaker

You can manage the speaker settings and control the speaker.

Enjoying the Music with “LG Wi-Fi Speaker” app

With “LG Wi-Fi Speaker” app, you can play music in your smart device.

! Note

Some of the content in this part may differ from “LG Wi-Fi Speaker” app depending on the application’s version.

Overview of the side menu

1. Launch “LG Wi-Fi Speaker” app on your smart device. [My Speakers] appears.
2. Tap [≡] button.

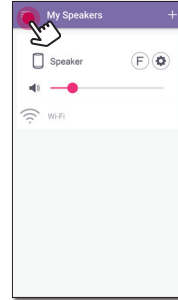

3. Side menu appears.

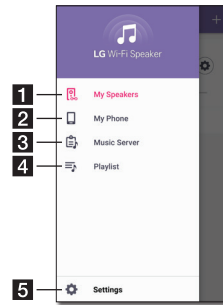

- 1 [My Speakers] – Displays the connected speaker.
- 2 [My Phone] – Displays the songs on this smart device.
- 3 [Music Server] – Displays the songs on the connected devices (Media server).
- 4 [Playlist] – Displays the playlists.
- 5 [Settings] – Displays the application settings.

! Note

It may request permission to use music.

Overview of [My Speakers]

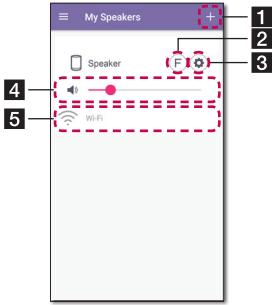

- 1** [+] – Connect additional speakers.

- 2** [Speaker] – Selects a function of the connected speaker.

- 3** [Settings] – Set up the connected speaker settings. (Page 9)

- 4** [Volume] – Adjust volume level of the connected speaker.

- 5** [Status] – Shows state of the connected speaker.

Playing a song

1. Select [My Phone] or [Music Server] on the side menu.

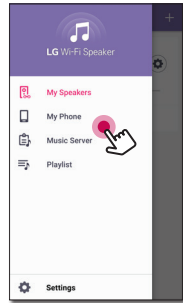

2. You can see songs on your smart device or music server. Select a song to play.
 In [My Phone] menu, the songs are sorted by [Album], [Artists], [Songs], [Genres] and [Folders] (Android device) or [iPhone Playlist] (iOS device).
 In [Music Server] menu, the connected servers appear.
3. Tap [Speaker] and select the speaker. You can listen to music through the connected speaker with Chromecast.

Managing a song

On the song list of [My Phone] or [Music Server], tap [⋮] of the desired song.

The pull down menu appears.

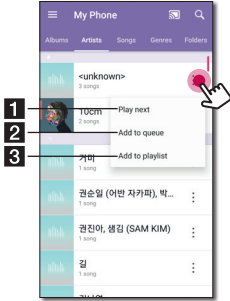

1 [Play next] – Selects music to play next.

2 [Add to queue] – Adds to queue list.

3 [Add to playlist] – Adds to a desired playlist.

! Note

Depending on your wireless environment, playing a song with the speaker may not work smoothly.

Using Playlist

You can enjoy music to suit your taste by making Playlist.

1. On the song list of [My Phone] or [Music Server], tap [⋮] of the desired song and [Add to playlist].

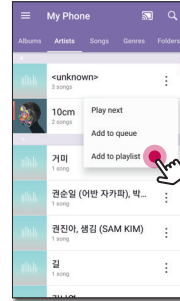

2. [Add to playlist] window appears.

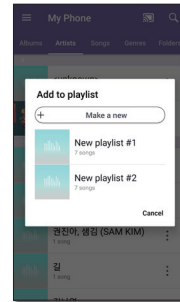

- Select a playlist to add the song.
- If you want to make another playlist, select [Make a new].

Overview of Playback

You can confirm and adjust various information on the playback screen.

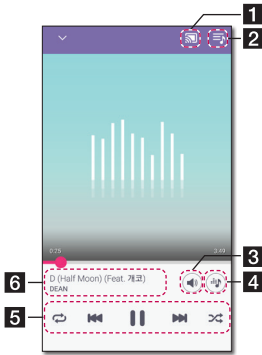

- 1 - Cast music to the connected speaker by Chromecast and stop casting the music.
- 2 - Edits the current playlist.
- 3 - Adjusts the volume of smart device or the volume of Chromecast.
- 4 - Adjusts the sound effect.
Adjusts playback.
 - Pauses playback.
 - Starts playback.
/ - Skips fast backward or forward.
- 5 - Repeats the desired contents.
Every time you click it, the state changed in (Repeat One) - (Repeat All) - (Repeat Off) order.
 - Shuffles the music on the list. Music will be played in random order.
- 6 Displays information about the currently playing song.

Note

is not available when you listen to music by your smart device or listen to music from speakers grouped with the Google [Home] app.

Selecting Sound effect

The app provides 4 sound effects (Clear Vocal+Enhanced Bass, Clear Vocal, Enhanced Bass or Standard). You can select a desired sound mode by tapping .

The displayed items for the equalizer may be different depending on the connected speaker, sound sources and effects.

1. During playback, tap .

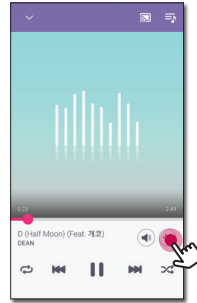

2. Select sound effect using **Enhanced Bass** and **Clear Vocal** and tap [OK].

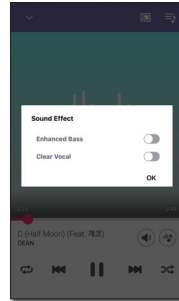

You can customize the sound effect by using to adjust Treble and Bass value.

Note

- When you listen to music via [My Phone] without speaker, the sound effect is not supported.
- Depending on the connected speaker, displayed sound effect may differ.

Sound effect mode

This system has a number of pre-set surround sound fields. You can select a desired sound effect by using "LG Wi-Fi Speaker" app.

Status	Description
Function	
<p>Enhanced Bass <input checked="" type="checkbox"/></p> <p>Clear Vocal <input checked="" type="checkbox"/></p> <p>Enhanced Bass + Clear Vocal</p>	<p>You can enjoy Clear Vocal and Enhanced Bass at the same time.</p>
<p>Enhanced Bass <input checked="" type="checkbox"/></p> <p>Clear Vocal <input type="checkbox"/></p> <p>Enhanced Bass</p>	<p>You can enjoy Wide sound field and rich bass with emphasis the bass and warmth of the music.</p> <p>Enhanced Bass is more effective for music with bass.</p>
<p>Enhanced Bass <input type="checkbox"/></p> <p>Clear Vocal <input checked="" type="checkbox"/></p> <p>Clear Vocal</p>	<p>You can enjoy High-fidelity sound with improved the vocal clarity of every lyric.</p> <p>Clear Vocal is more effective for music with vocal.</p>
<p>Enhanced Bass <input type="checkbox"/></p> <p>Clear Vocal <input type="checkbox"/></p> <p>Standard</p>	<p>You can enjoy pure and natural sound.</p>

! Note

- When you turn the speaker back on, the last used option will be on.
- When you select "Standard" "Enhanced Bass", "Clear Vocal" or "Clear Vocal + Enhanced Bass" sound effect, you can enjoy premium sound with MERIDIAN technology.
- Because fine-tune sound to provide optimal high-quality sound, It might be a little difference between sound effect modes.

Settings

With “LG Wi-Fi Speaker” app, you can set the connected speaker in your smart device.

! Note

Some of the content in this part may differ from “LG Wi-Fi Speaker” app depending on the application’s version.

Settings of the connected speaker

You can set up setting of the connected speaker.

On [My Speakers] screen, select [⊙] to set up the connected speaker settings.

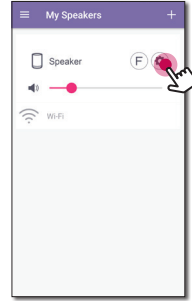

! Note

You cannot see some menu depending on the connected device.

Settings of the connected speaker appear.

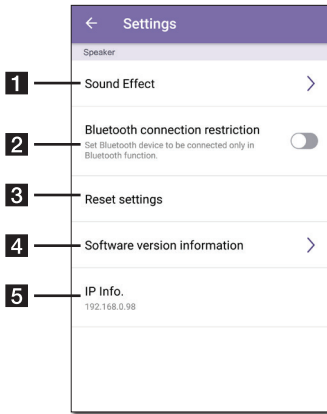

1 **[Sound Effect]** - Selects a sound effect mode (Clear Vocal+Enhanced Bass, Clear Vocal, Enhanced Bass or Standard). (Page 8)

2 **[Bluetooth connection restriction]** - It enables you to connect Bluetooth device only on Bluetooth.

3 **[Reset settings]** - Resets the speaker settings (Volume, Sound effect, Function, Bluetooth setting).

4 **[Software version information]** - Displays the current Software version information and updates the software to latest version.

5 **[IP Info.]** - Shows the IP address of the speaker.

Settings of “LG Wi-Fi Speaker” app

Select [Settings] on the side menu.

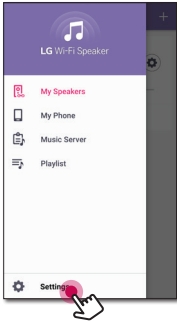

Settings of “LG Wi-Fi Speaker” app appear.

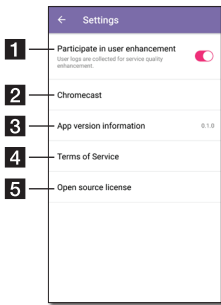

- 1** **[Participate in user enhancement]** – Allows to send user logs for service quality enhancement.
- 2** **[Chromecast]** – Displays the Chromecast menu.
- 3** **[App version information]** – Displays this application version information.
- 4** **[Terms of Service]** – Displays Terms of Service.
- 5** **[Open source licenses]** – Shows LGE Open Source Software Notice.

[Chromecast] Menu



- 1** **[Learn how to cast]** - Shows how to use Chromecast.
- 2** **[Cast Groups]** - Select [Learn about Cast Groups] or [How to cast to a group] to show the selected information.
- 3** **[Chromecast built-in open legal documents]** - Select [Google Terms of Service], [Google Privacy Policy] or [Open source licenses] to show the selected information.
- 4** **[Time zone]** - Sets time zone.

! Note

To use Cast Groups, install Google [Home] application. Download the application from Apple “App Store” or Google “Play Store.”

[Time Zone] Menu

Automatic Time zone

It offers to use network provided time.

Set Time Zone

If you deselect [Automatic Time zone], you can select your time zone yourself.

